

korpus

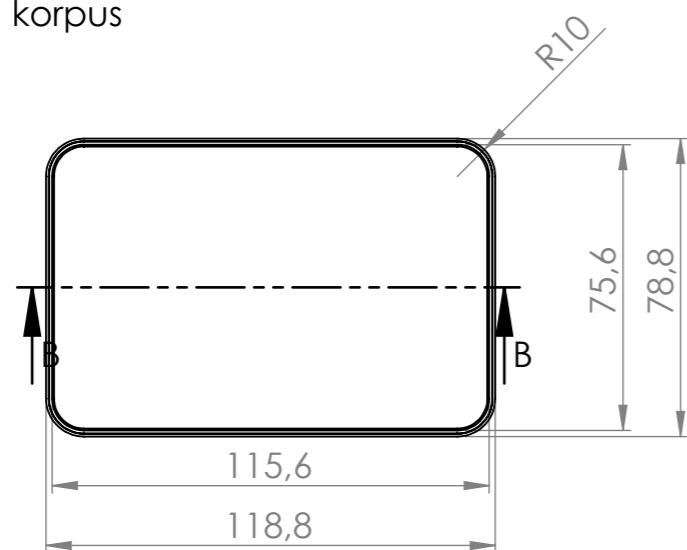

pokrywa

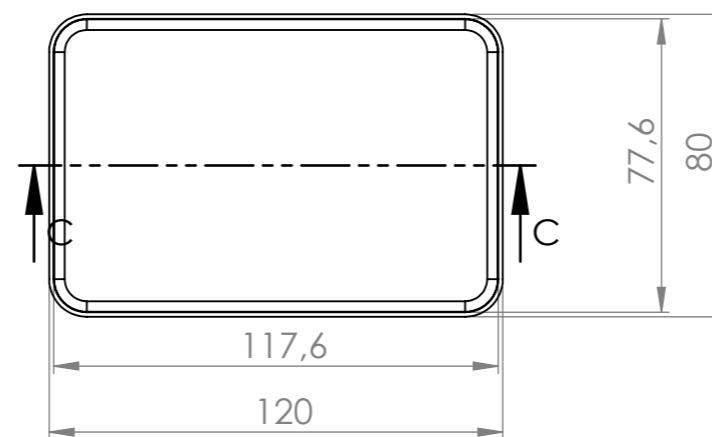

złożenie

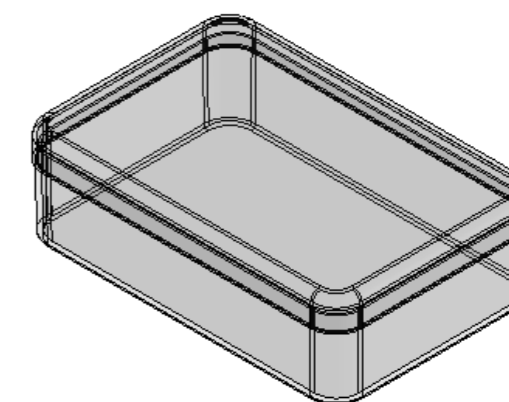
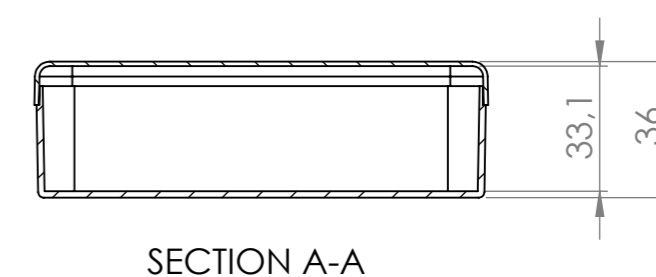
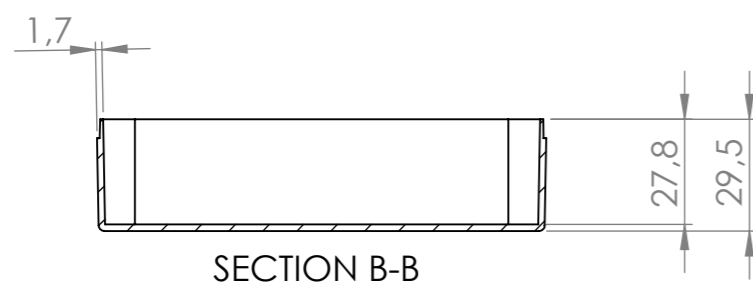
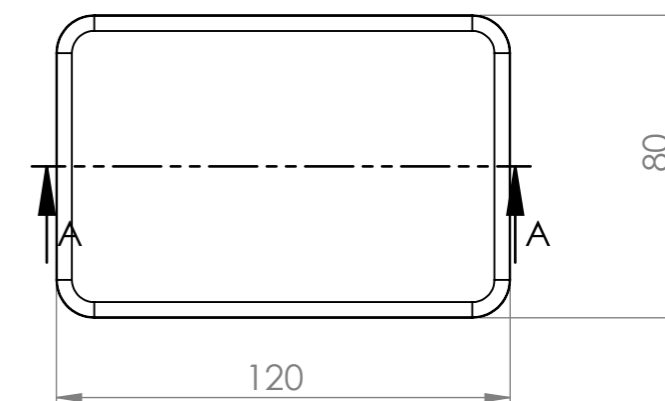

Tolerancja wymiarowa $\pm 0,5$ mm

| | | |
|-------------|--|---|
| Format | Skala |  MASZCZYK [®] OBUDOWY DLA ELEKTRONIKI |
| A3 | 1:2 | |
| Nr Produktu | „MASZCZYK” 05-071 Sulejówek-Miłosna ul. Mickiewicza 10 tel: (22) 783-45-20 kom: 602-726-086 | |
| KM - 163 | | |