

PRZEKRÓJ A-A

Tolerancja wymiarowa $\pm 0,5$ mm

Format A3	Skala 1:1
Nr produktu TC-206	



MASZCZYK SP. J.
05-252 Małopole
ul. Graniczna 24

Tel: +48 602 726 086
maszczyk@maszczyk.pl

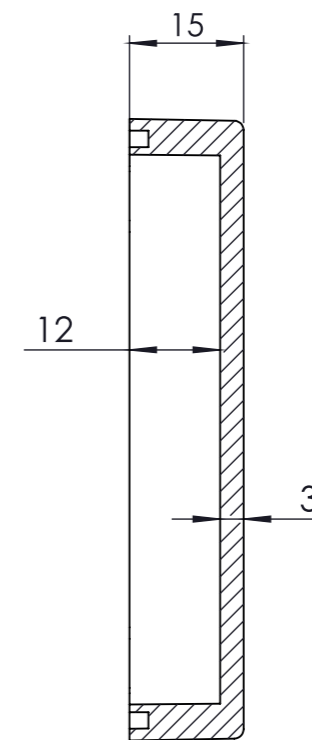
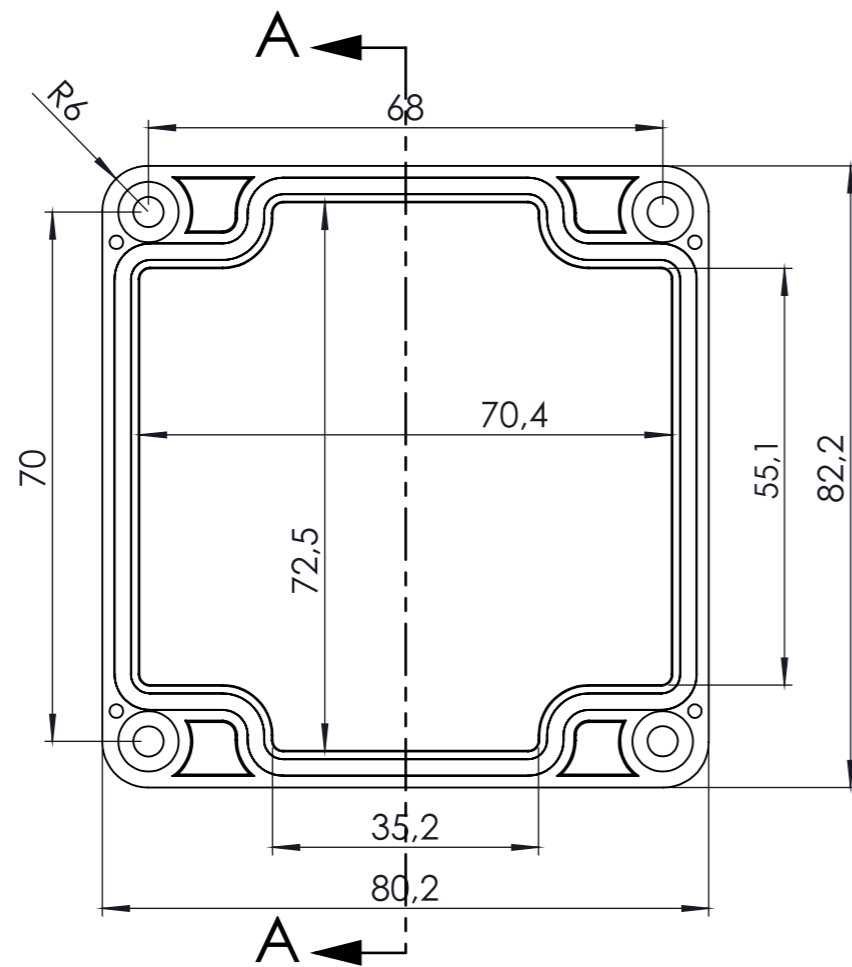

PRZEKRÓJ A-A

Tolerancja wymiarowa $\pm 0,5$ mm

Format A3	Skala 1:1	 MASZCZYK[®] OBUDOWY DLA ELEKTRONIKI
Nr produktu TC-206		
MASZCZYK SP. J. 05-252 Małopole ul. Graniczna 24		Tel: +48 602 726 086 maszczyk@maszczyk.pl

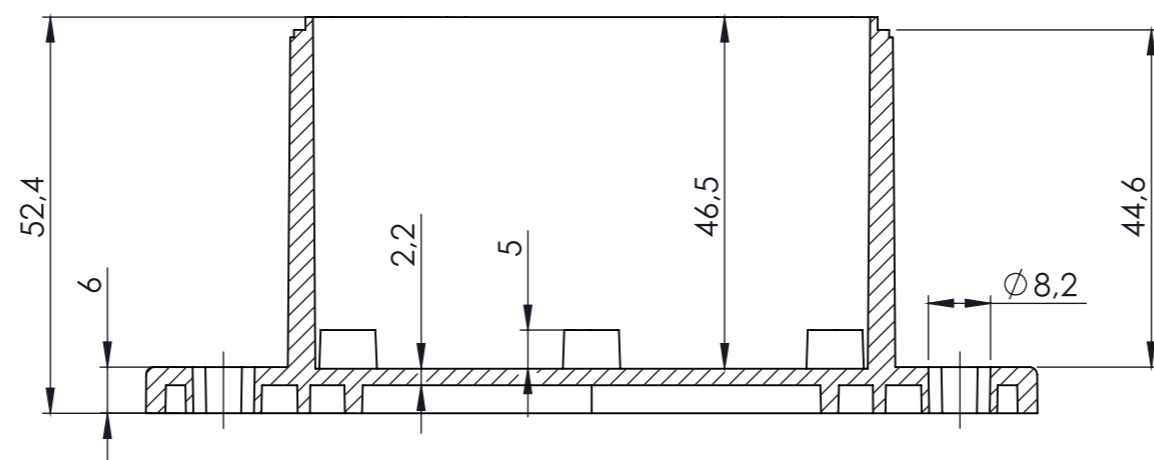
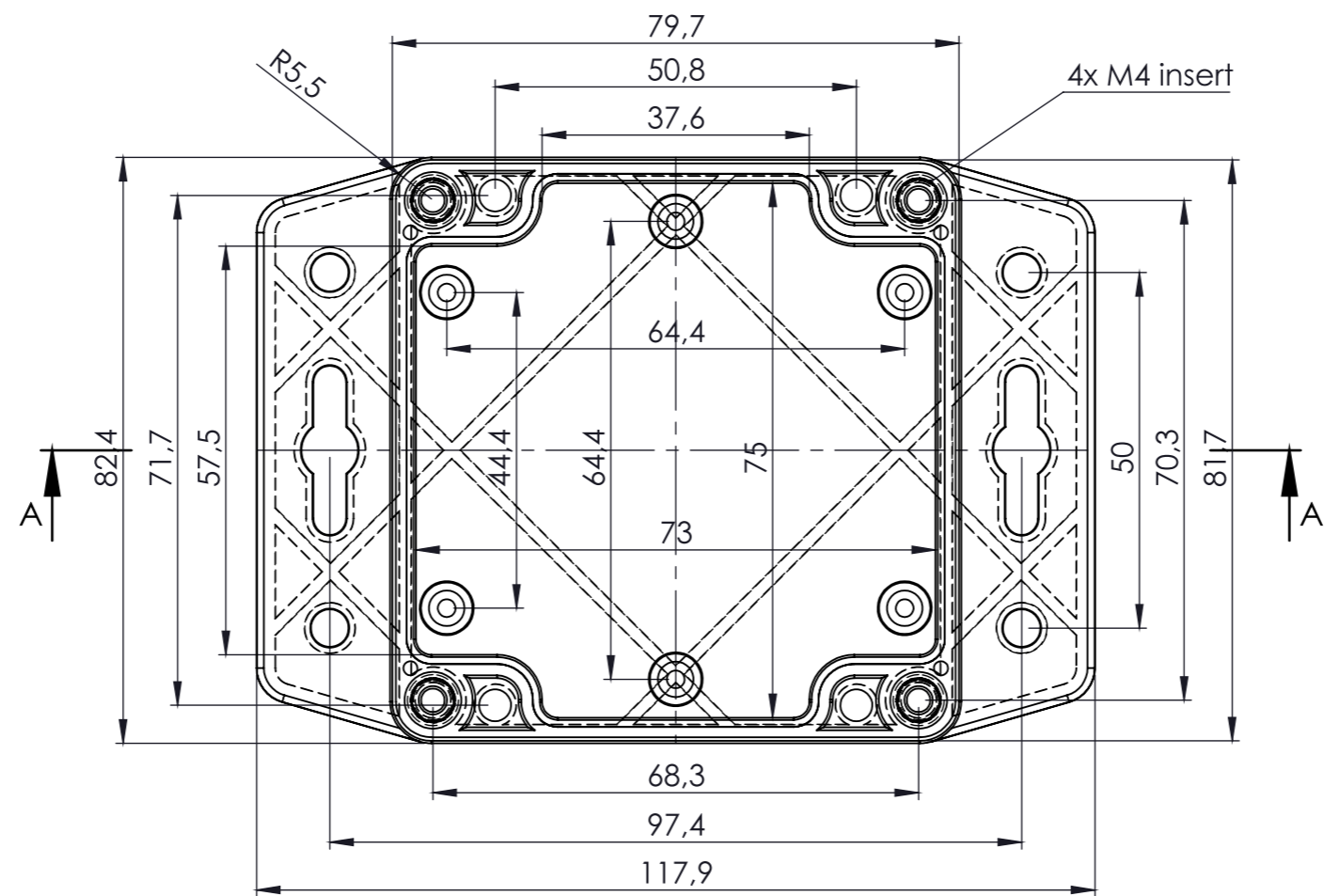

PRZEKRÓJ A-A

Tolerancja wymiarowa $\pm 0,5$ mm

Format A3	Skala 1:1
Nr produktu TC-206	



MASZCZYK SP. J.
05-252 Małopole
ul. Graniczna 24
Tel: +48 602 726 086
maszczyk@maszczyk.pl

PŁYTKA PCB (OPCJONALNIE)

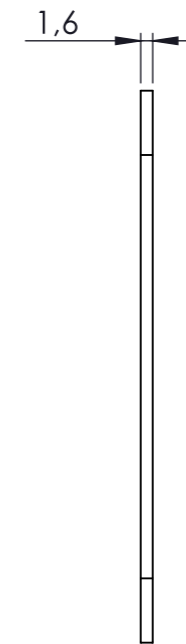
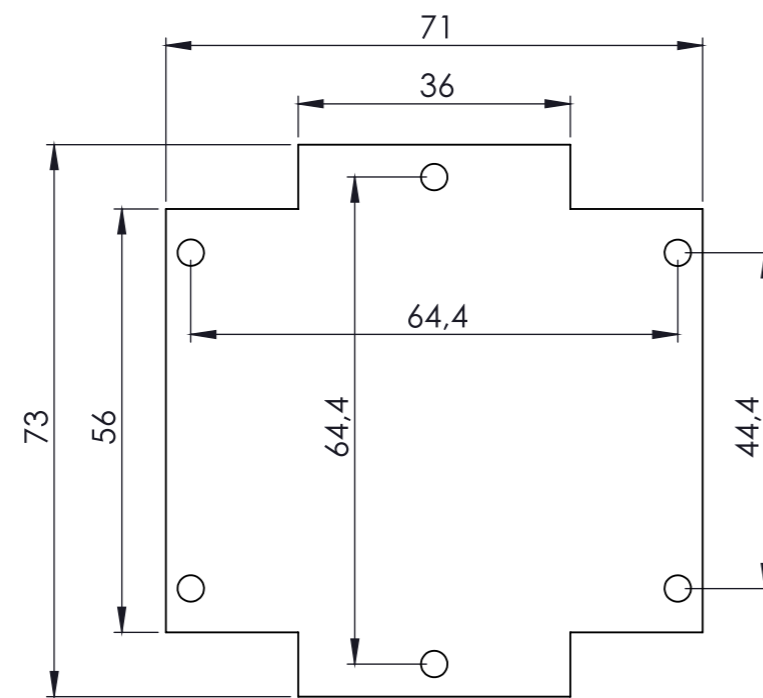

Tolerancja wymiarowa $\pm 0,5$ mm

Format A3	Skala 1:1	 MASZCZYK [®] OBUDOWY DLA ELEKTRONIKI
Nr produktu TC-206		
MASZCZYK SP. J. 05-252 Małopole ul. Graniczna 24		Tel: +48 602 726 086 maszczyk@maszczyk.pl