

PRZEKRÓJ D-D

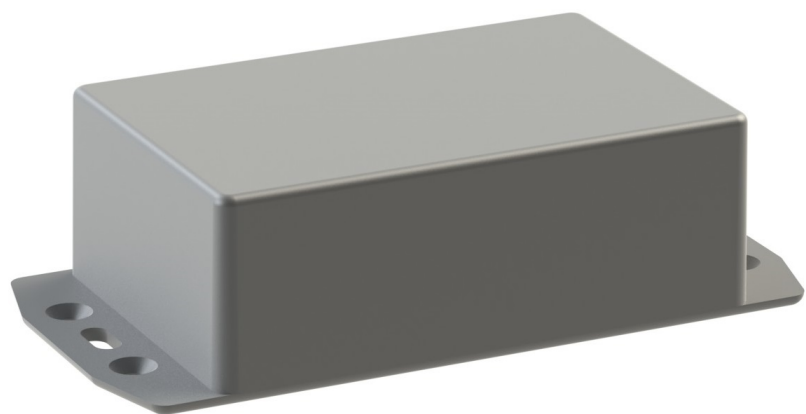

Tolerancja wymiarowa $\pm 0,5$ mm

maxPCB: 58x47 mm

Elementy składowe:

- korpus
- pokrywa
- 4x wkręt
- 4x zaślepka

Format
A4

Skala
1:1

Nr produktu

KM -116U



MASZCZYK[®]
OBUDOWY DLA ELEKTRONIKI

„MASZCZYK”
05-071 Sulejówek-Miłosna
ul. Mickiewicza 10
tel: (22) 783-45-20 kom: 602-726-086

korpus

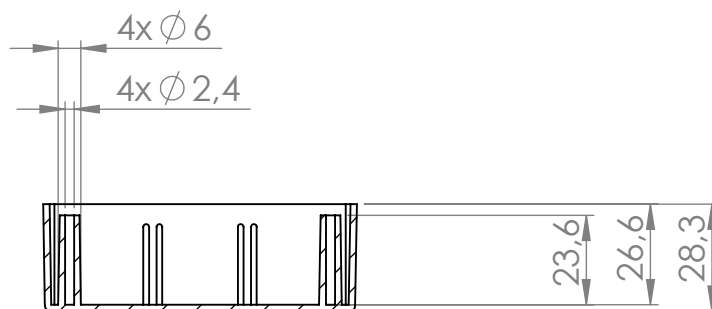
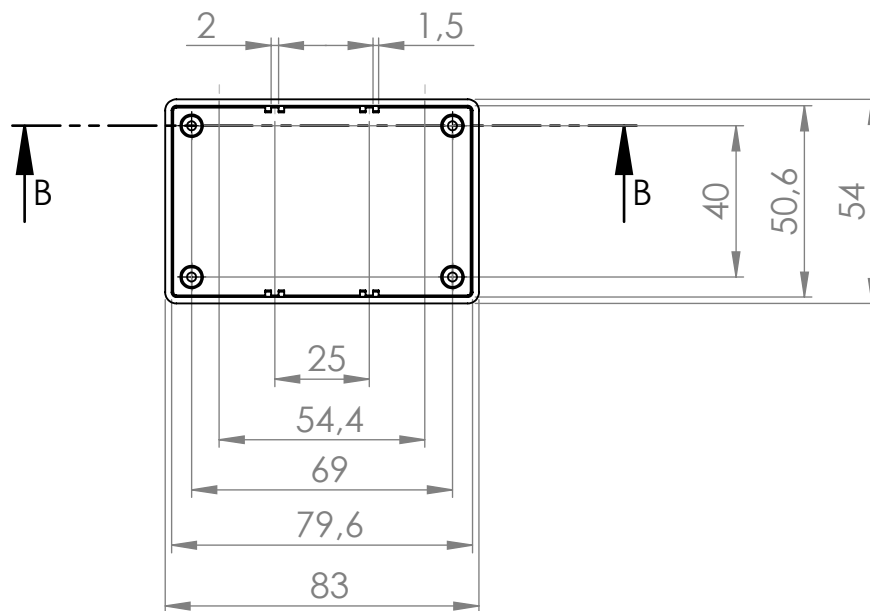

PRZEKRÓJ B-B



Tolerancja wymiarowa $\pm 0,5$ mm

| | | |
|--------------------------|--------------|--|
| Format A4 | Skala 1:2 |  MASZCZYK [®] OBUDOWY DLA ELEKTRONIKI „MASZCZYK” 05-071 Sulejówek-Miłosna ul. Mickiewicza 10 tel: (22) 783-45-20 kom: 602-726-086 |
| Nr produktu KM - 116U | | |

pokrywa

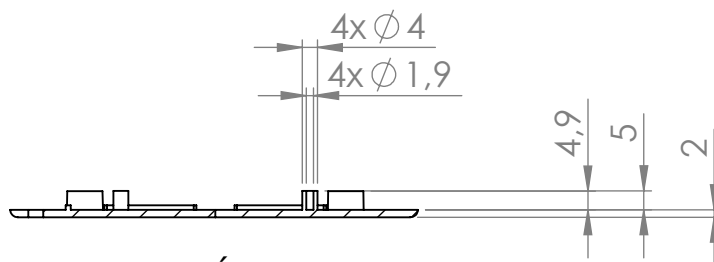
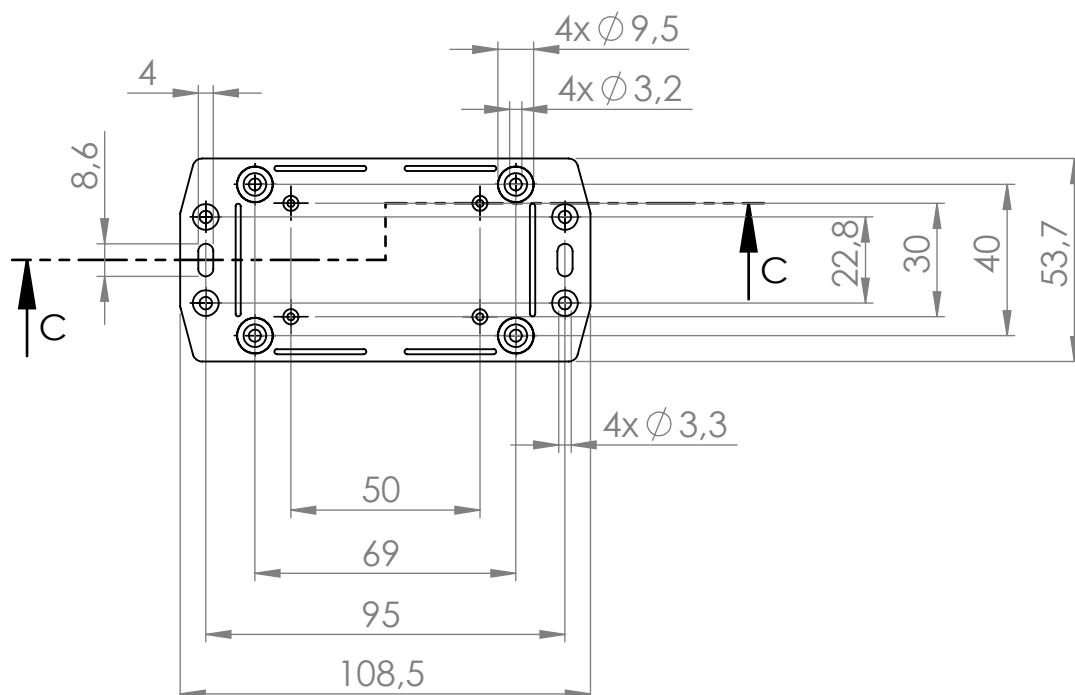

PRZEKRÓJ C-C

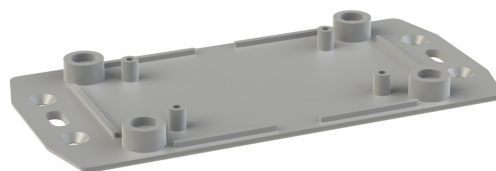

Tolerancja wymiarowa $\pm 0,5$ mm

| | |
|--------------------------|--------------|
| Format A4 | Skala 1:2 |
| Nr produktu KM - 116U | |



„MASZCZYK”
05-071 Sulejówek-Miłosna
ul. Mickiewicza 10
tel: (22) 783-45-20 kom: 602-726-086