

PRZEKRÓJ A-A

Góra

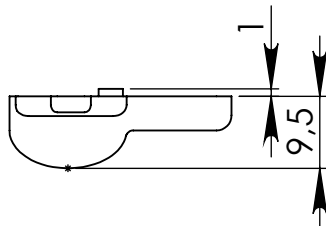

Dół

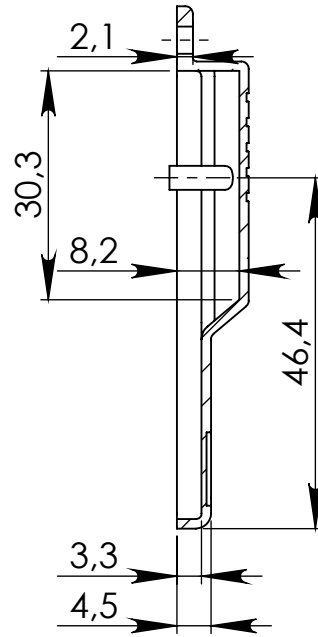
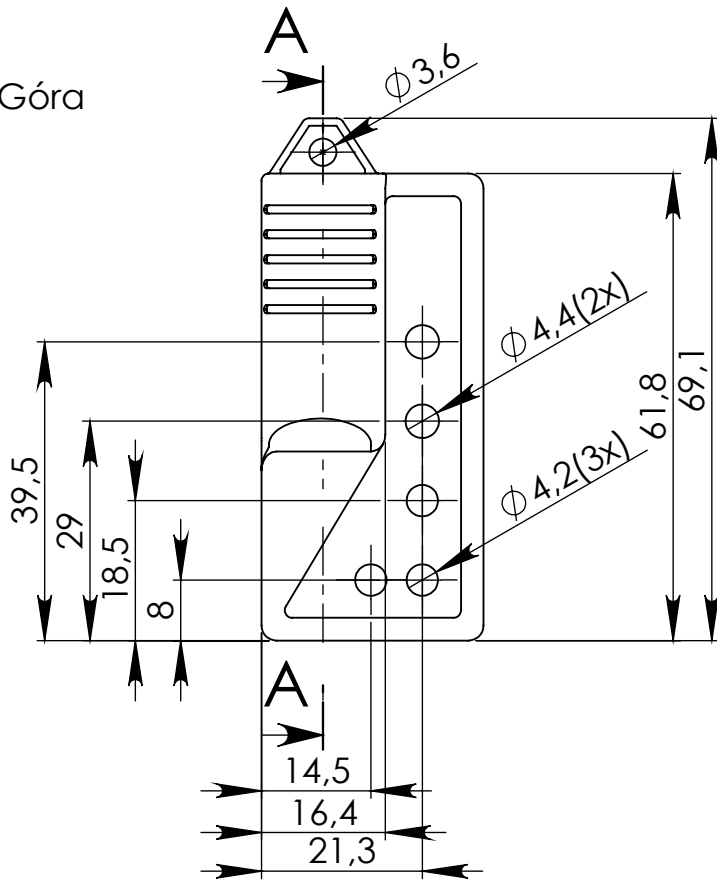
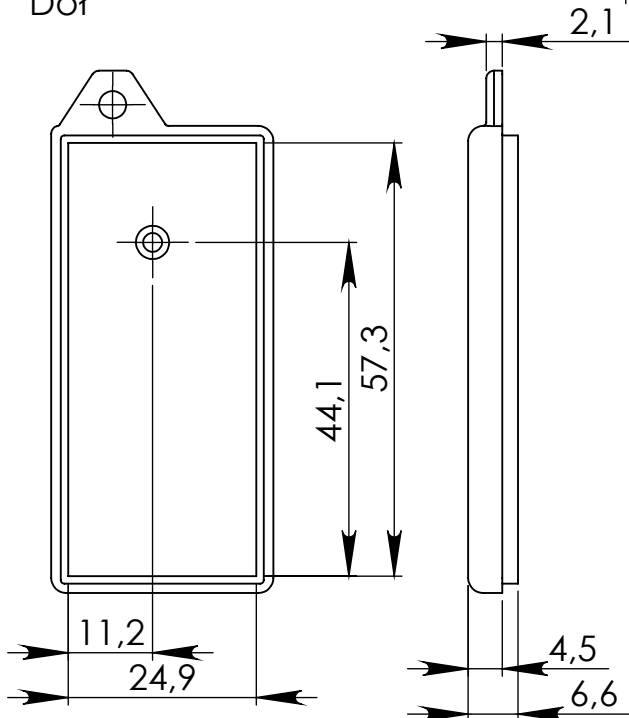

Klawiatura

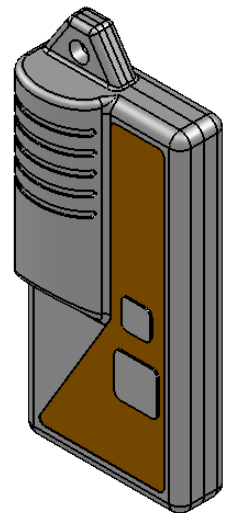
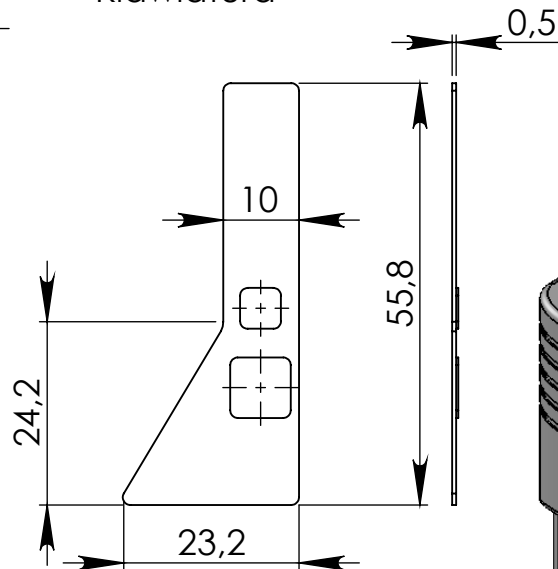

UWAGA: Wymiary w tolerancji $\pm 0,5\text{mm}$

- Elementy składowe:
- obudowa góra,
 - obudowa dół,
 - klawiatura (naklejka),
 - 1 wręć,

Format	Skala
A4	1:1
Nr produktu	
KMp 11-2	



MASZCZYK®

Krzysztof Maszczyk
05-071 Sulejówek-Miłosna
ul. Mickiewicza 10
tel.: (022)783 45 20, fax.: (022)783 90 85
kom: 0602 726 086