

PRZEKRÓJ A-A

Tolerancja wymiarowa $\pm 0,5$ mm

Format A3	Skala 1:2	 MASZCZYK [®] OBUDOWY DLA ELEKTRONIKI
Nr produktu TC-256		
MASZCZYK SP. J. 05-252 Małopole ul. Graniczna 24		Tel: +48 602 726 086 maszczyk@maszczyk.pl

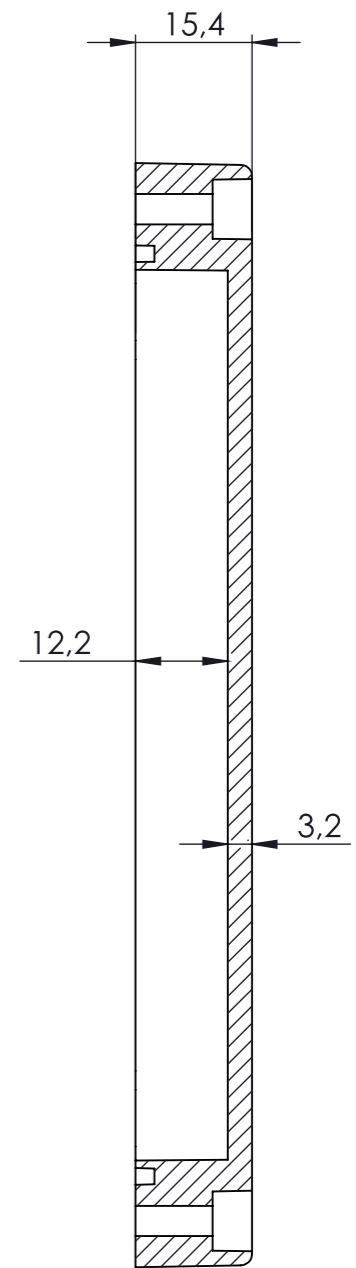
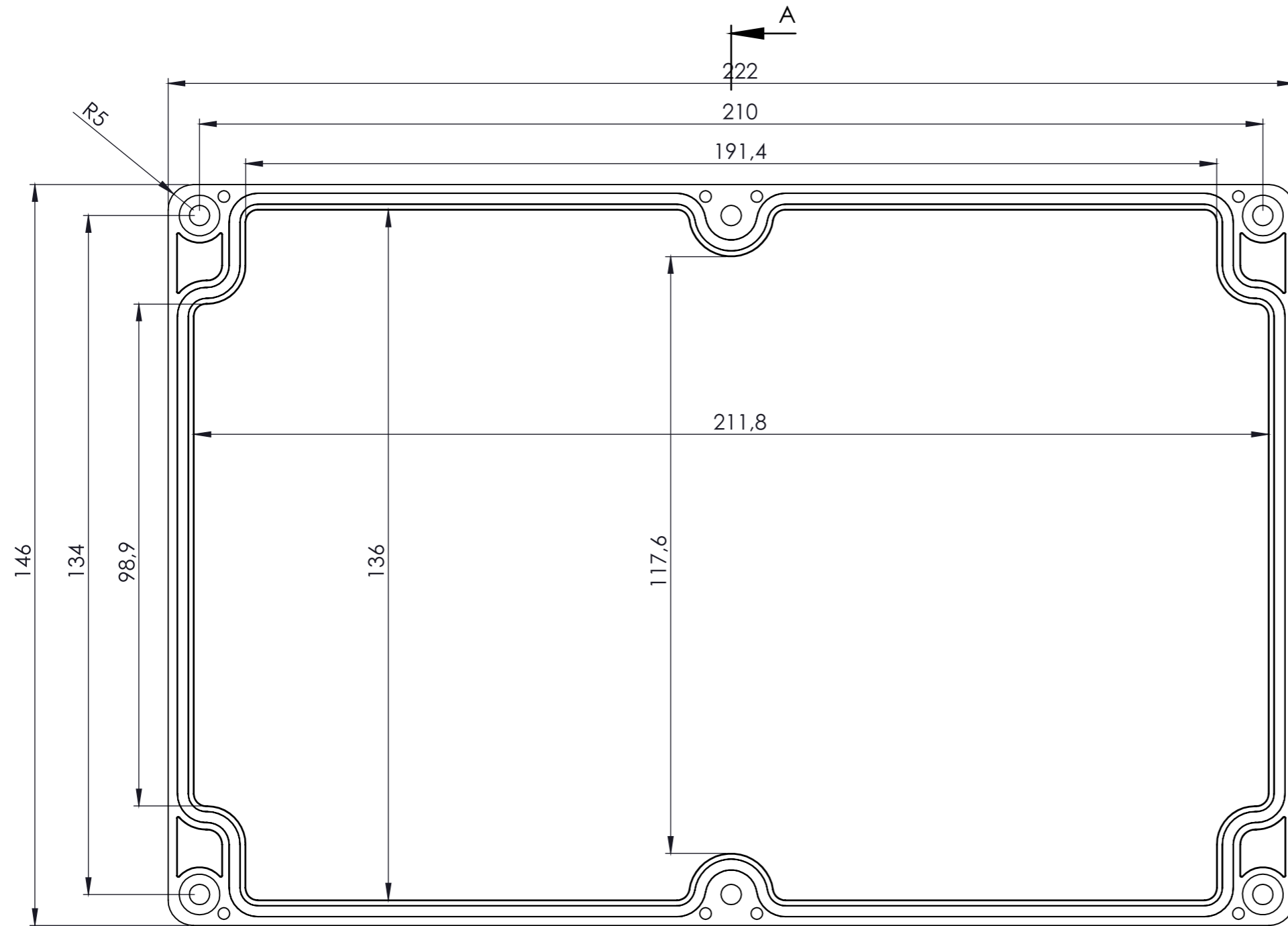

PRZEKRÓJ A-A



Tolerancja wymiarowa $\pm 0,5$ mm

Format A3	Skala 1:1	 MASZCZYK [®] OBUDOWY DLA ELEKTRONIKI
Nr produktu TC-256		
MASZCZYK SP. J. 05-252 Małopole ul. Graniczna 24		Tel: +48 602 726 086 maszczyk@maszczyk.pl

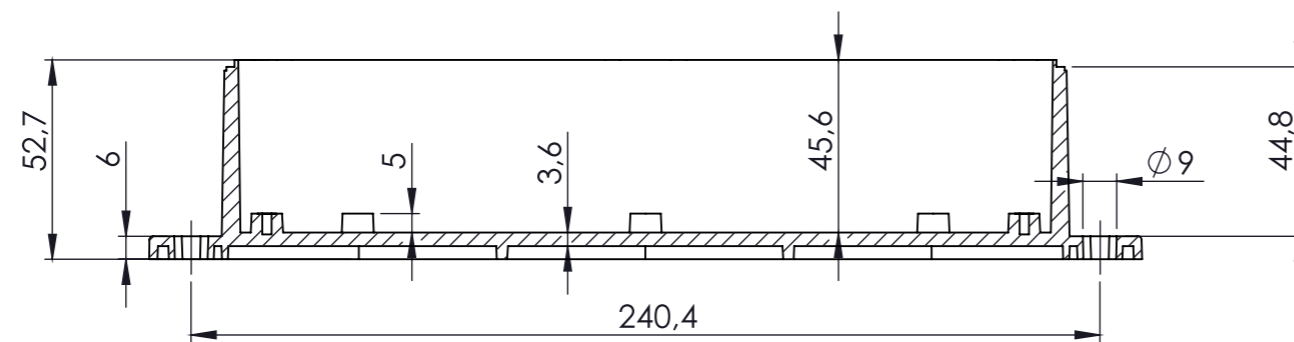
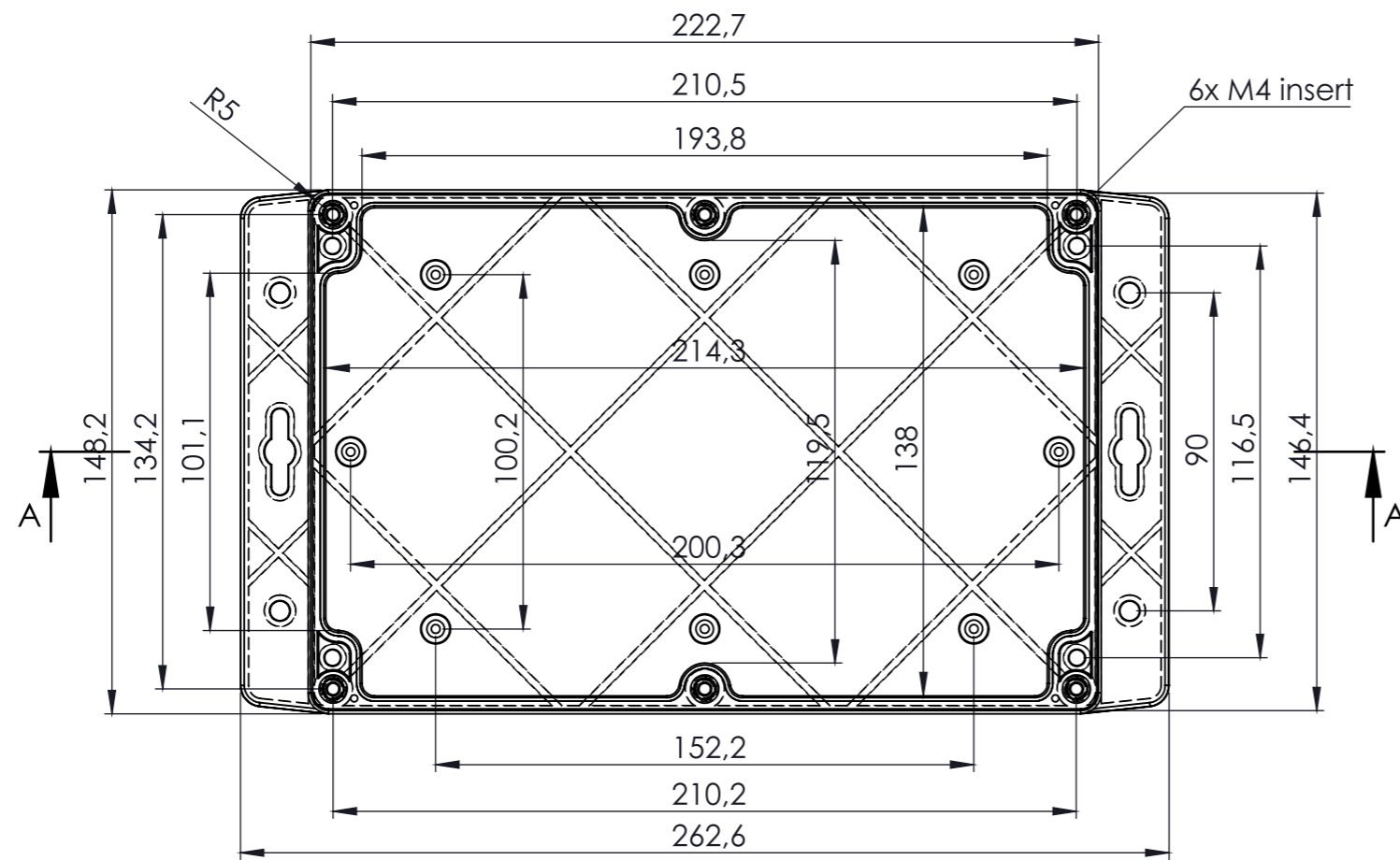

PRZEKRÓJ A-A

Tolerancja wymiarowa $\pm 0,5$ mm

Format A3	Skala 1:2	 MASZCZYK [®] OBUDOWY DLA ELEKTRONIKI
Nr produktu TC-256		
MASZCZYK SP. J. 05-252 Małopole ul. Graniczna 24		Tel: +48 602 726 086 maszczyk@maszczyk.pl

PŁYTKA PCB (OPCJONALNIE)

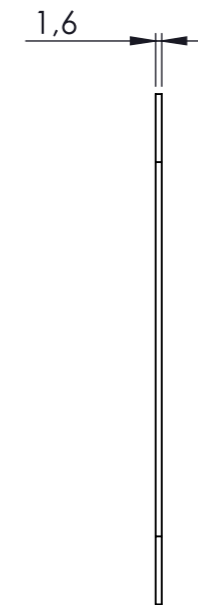
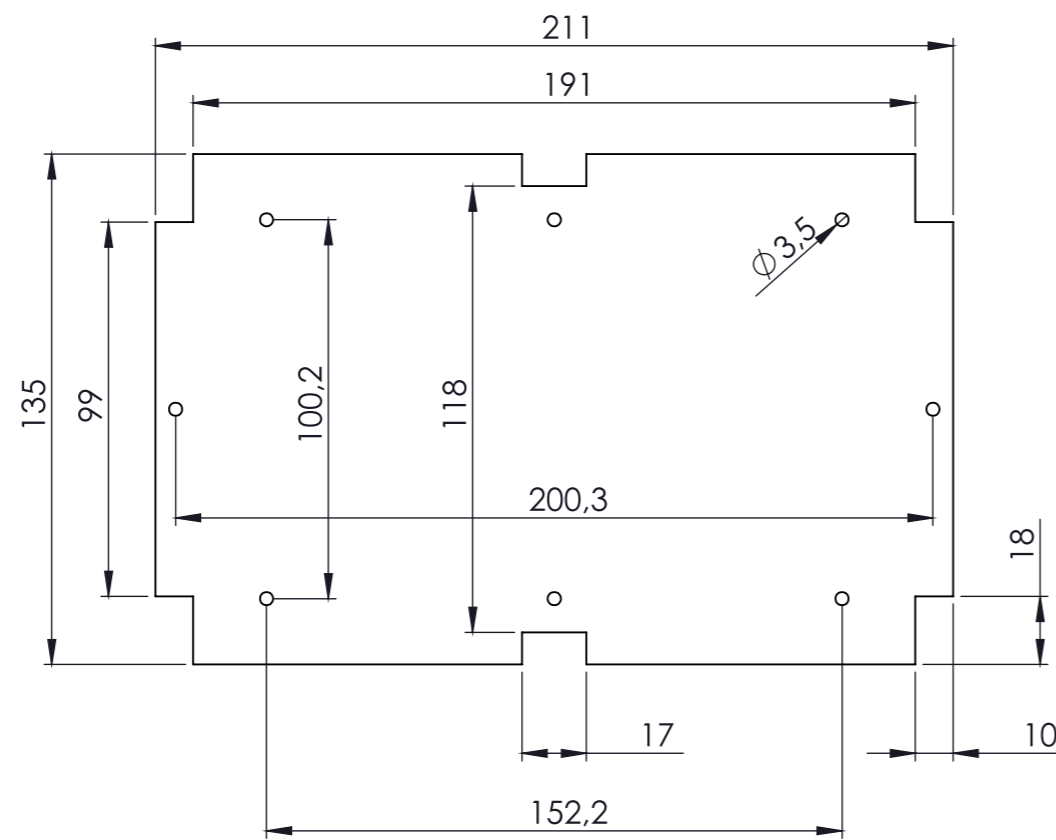

Tolerancja wymiarowa $\pm 0,5$ mm

Format A3	Skala 1:2	 MASZCZYK [®] OBUDOWY DLA ELEKTRONIKI
Nr produktu TC-256		
MASZCZYK SP. J. 05-252 Małopole ul. Graniczna 24		Tel: +48 602 726 086 maszczyk@maszczyk.pl